

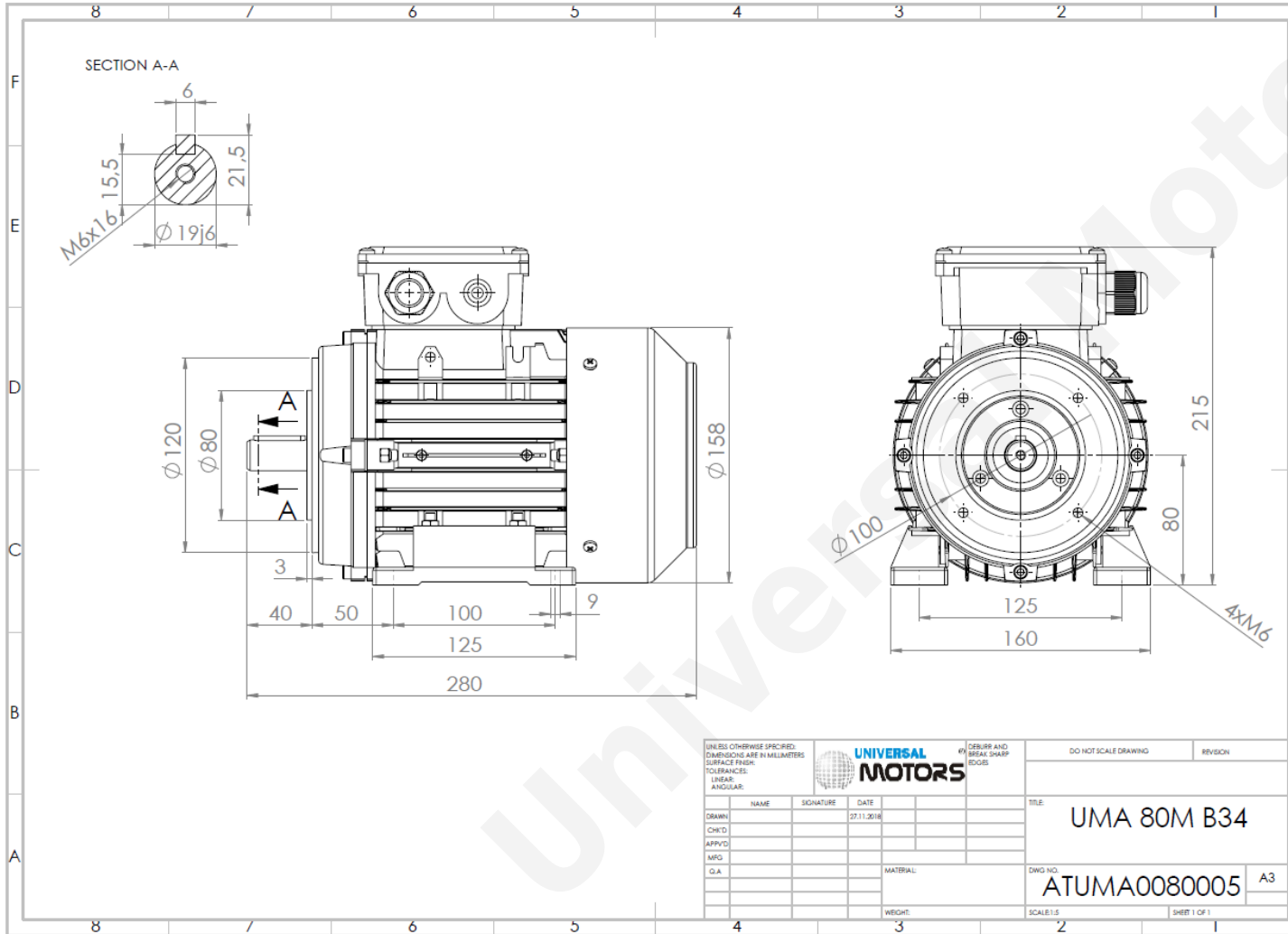

TECHNICAL DATA

Three Phase Electric Motors - Aluminum Frame
 UM2A 80M1-4
 0.55 kW / 0.75 Cv
 1420 RPM



Motor type:	UM2A 80M1-4
Output:	0.55 kW / 0.75 Cv
Speed (min ⁻¹):	1420 RPM
Frequency:	50 Hz
Voltage:	400 V
Current:	1.41 A
Power factor (Cos Ø):	0.70
Poles:	4
Insulation class:	F
Temperature rise Class:	B
Efficiency 50%:	73.9 %
Efficiency 75%:	77.1 %
Efficiency 100%:	77.1 %
Torque:	3.70 N.m
Tstarting/Tnominal:	2.4
Istarting/Inominal:	5.4
Tmaximum/Tnominal:	2.8
Noise:	57 Db(A)
Weight:	8.9 Kg
Brake AC:	AC3
Torque Brake DC:	8 N.m
Bearing DE:	6204 2Z
Bearing NDE:	6204 2Z
Torque Brake AC:	15 N.m
Brake DC:	REB-05-08

Regime - S1

Altitude - 1000m

Environment Temperature - 40°C

CONTACTS:

UNIVERSAL MOTORS Tel: +351 252 299 080
 Rua de São Brás,745 Fax: +351 252 299 089
 4480-782 VILA DO CONDE Mail: geral@universalmotors.pt

* References applied only in the UK